	COMMUNICATION PROTOCOL	PR 150	Rev. A
		31/01/2018	Pag 1
	Multifunction	Firmware \geq 1.101	
NEMO 96 EA ModBus			



Sommario

1. ABSTRACT.....	2
1.1. Physical level.....	2
1.2. Data link level.....	2
1.3. Application level.....	2
2. DATA MESSAGE DESCRIPTION.....	3
2.1. Parameters description.....	3
2.2. Data format.....	4
2.3 Description of CRC calculation.....	4
2.4. Error management.....	5
2.5. Timing table.....	5
2.6. Requests.....	6
2.7. Assignments.....	6
3. VARIABLES.....	7
3.1. Notes.....	14
4. Setup parameters remote settings, Resets and Programming.....	15
5. Pulse Output Module – IF96003.....	16
6. Twin Alarm OUT module - IF96005.....	16
7. Twin Analogue OUT module – IF96004.....	17
8. Neutral Current module - IF96006.....	18
9. I/O module - IF96010 / IF96011.....	19
9.1. Pulse counting – Input status.....	19
9.2. Pulse counters - reset.....	20
9.3. Alarm out - setting.....	21
10. Double Temperature measurement module - IF96016.....	22
11. Standard Programming Parameters.....	23
12. Remote Reset and Programming.....	24
13. Historic Write Address Table.....	25
13.3. Historic Set and Reset.....	28
13.4. Historic Data record types.....	29
14.1. Real time data Type 4: bit mapped variable reading.....	32
14.2. Real time data Type 4 : bit mapped variable writing.....	33
14.3. Real time data reading.....	34
15. Power quality reading.....	35

Revisione A	Donofrio M.	Rigamonti A.	Donofrio M.
	Compilato	Controllato	Approvato

	COMMUNICATION PROTOCOL	PR 150	Rev. A
		31/01/2018	Pag 2
Multifunction		Firmware ≥ 1.101	
NEMO 96 EA ModBus			

1. ABSTRACT

1.1. Physical level

The physical communication line complies with the EIA-RS485 standard in half-duplex modality. In this case, as only two wires are used, only one instrument at a time can engage the line; this means that there must be a master which polls the slave instruments so the demand and the request are alternated. On the same physical line only 32 instruments can be attached (master included). In order to increase the number of the slave instrument, the necessary repeaters must be used.

The communication parameters are :

Baud rate : programmable (device dependant)
bit n. : 8
stop bit : 1
parity : programmable (device dependant)
Data Fotmat : programmable Big-Endian / Little-Endian
Swap-Word : programmable (only for Double Word)

1.2. Data link level

The data are transmitted in a packet form (message) and are checked by a word (CRC). See the description of the data packet in the next paragraphs for more details.

1.3. Application level

The communication protocol used is MODBUS / JBUS compatible. Up to 255 different instruments can be managed by the protocol. There are no limitations to the number of possible retries done by the master. A delay between the response from the slave and the next command could be necessary and it is specified for each device (timing).

Revisione A	M. D'Onofrio	A. Rigamonti	M. D'Onofrio
	Compilato	Controllato	Approvato

	COMMUNICATION PROTOCOL	PR 150	Rev. A
		31/01/2018	Pag 3
Multifunction		Firmware ≥ 1.101	
NEMO 96 EA ModBus			

2. DATA MESSAGE DESCRIPTION

The generic data message is composed as following :

Device address	Functional code	Data	CRC word
----------------	-----------------	------	----------

Two answers are possible :

Answer containing data

Device address	Functional code	Data	CRC word
----------------	-----------------	------	----------

No answer or bad data answer (Error !)

Device address	Functional code + 0x80	Error code	CRC word
----------------	------------------------	------------	----------

2.1.Parameters description

Device address : device identification number in the network. It must be the same for the demand and the answer.

0x00 is for broadcast messages with no answer

0x03 : Read Holding Registers

0x10 : Preset Multiple Registers

Format : 1 BYTE from 1 to 255 (extended Range)

Functional code : command code

Format : 1 BYTE

0x00 is for broadcast messages with no answer

0x03 : Read Holding Registers

0x10 : Preset Multiple Registers

Data : they are

- the address of the required words + words number (in the demand)

- bytes number + data (in the answer)

CRC 16 : it is the result of the calculation done on all the bytes in the message

Revisione A	M. D'Onofrio	A. Rigamonti	M. D'Onofrio
	Compilato	Controllato	Approvato

	COMMUNICATION PROTOCOL	PR 150	Rev. A
		31/01/2018	Pag 4
Multifunction		Firmware ≥ 1.101	
NEMO 96 EA ModBus			

2.2. Data format

The following types of format are used for the data values :

- * U_WORD : one WORD - Unsigned word
- * S_WORD : one WORD - Signed word
- * UD_WORD : two WORDS - Unsigned Double Word
- * SD_WORD : two WORDS - Signed Double Word

If the required data is in a DWORD format, 2 WORDS are transmitted and the MSW comes before the LSW (depending on the setting in the NEMO 96 : **big endian / little endian / SWAP Words** Default = Big-Endian)

MSB	LSB	MSB	LSB
Most Significant WORD		Least Significant WORD	

Example : 1000 decimal = 0x 00 00 03 E8 (if UDWord and Big-Endian format)

Most Significant WORD		Least Significant WORD	
MSB	LSB	MSB	LSB
0x00	0x00	0x03	0xe8

2.3 Description of CRC calculation

The following is an example of the CRC 16 calculation in C language.

```

unsigned int calc_crc (char *ptbuf, unsigned int num)
/* *****/
*   Descrizione : calculates a data buffer CRC WORD
*   Input      :   ptbuf = pointer to the first byte of the buffer
*                 num  = number of bytes
*   Output     : //
*   Return     :
**  *****/
{
  unsigned int crc16;
  unsigned int temp;
  unsigned char c, flag;
  crc16 = 0xffff;          /* init the CRC WORD */
  for (num; num>0; num--) {
    temp = (unsigned int) *ptbuf;    /* temp has the first byte */
    temp &= 0x00ff;                /* mask the MSB */
    crc16 = crc16 ^ temp;          /* crc16 XOR with temp */
    for (c=0; c<8; c++) {
      flag = crc16 & 0x01;        /* LSBit di crc16 is mantained */
      crc16 = crc16 >> 1;        /* Lsbit di crc16 is lost */
      if (flag != 0)
        crc16 = crc16 ^ 0x0a001; /* crc16 XOR with 0x0a001 */
    }
    ptbuf++;                      /* pointer to the next byte */
  }
  crc16 = (crc16 >> 8) | (crc16 << 8); /* LSB is exchanged with MSB */
  return (crc16);
} /* calc_crc */

```

Revisione A	M. D'Onofrio	A. Rigamonti	M. D'Onofrio
	Compilato	Controllato	Approvato

2.4. Error management

Function Code Field: In a normal response, the slave echoes the function code of the original query in the function code field of the response. All function codes have a most-significant bit (MSB) of 0 (their values are all below 80 hexadecimal).

In an exception response, the slave sets the MSB of the function code to 1. This makes the function code value in an exception response exactly 80 hexadecimal higher than the value would be for a normal response.

With the function code's MSB set, the master's application program can recognize the exception response and can examine the data field for the exception code.

Data Field: In a normal response, the slave may return data or statistics in the data field (any information that was requested in the query). In an exception response, the slave returns an exception code in the data field. This defines the slave condition that caused the exception.

Supported Error Codes :

- * 0x01 : Illegal Function
- * 0x02 : Illegal Data Address
- * 0x03 : Illegal Data Value

2.5. Timing table

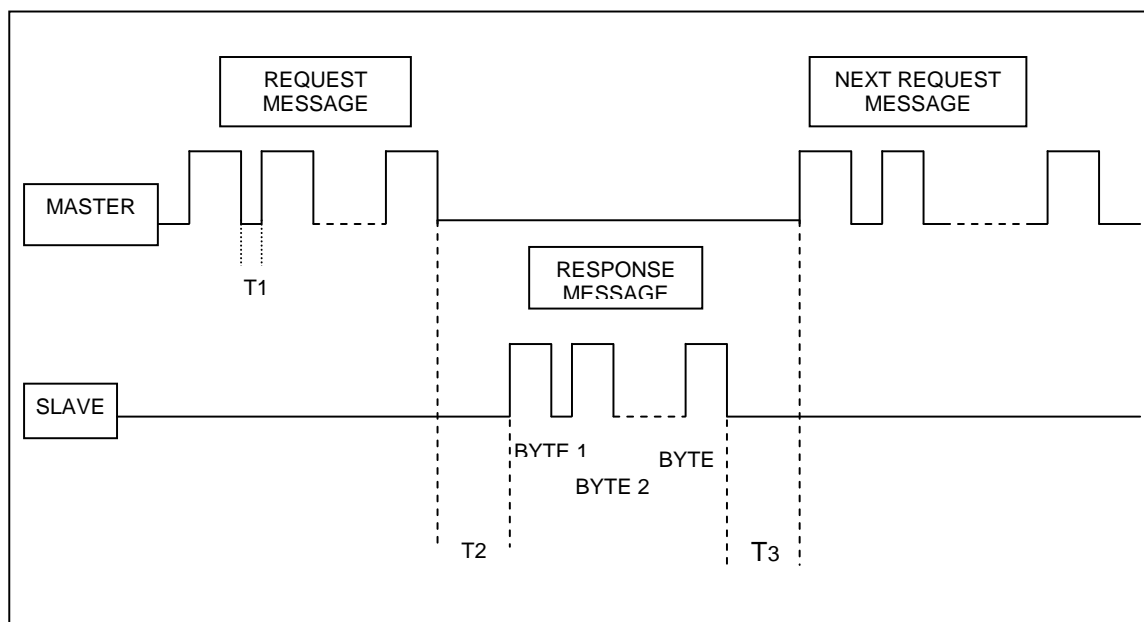

TIME	DESCRIPTION	Min & Max VALUES
T1	Time between characters. If this time exceeds the max. time allowed, the message is not considered by device.	Max < 20 ms.
T2	Slave response time Minimum and maximum response time of device to the Master request.	Min = 20 ms. Max = 150ms.
T3	Time before a new message request from the Master	Min = 20 ms.

Be careful : among the setup parameters there is a timeout value that may be programmed the value of 20 msec is suggested to keep compatibility with older IME devices. The minimum value is 3 msec.

Revisione A	M. D'Onofrio	A. Rigamonti	M. D'Onofrio
	Compilato	Controllato	Approvato

2.6. Requests

Code 0x03 : Reading one or more consecutive WORDS

Request format :

BYTE	BYTE	MSB	LSB	MSB	LSB	LSB	MSB
Device address	Funct. Code	First WORD address		WORDS number		CRC16	

Answer format (containing data) :

BYTE	BYTE	BYTE	MSB	LSB	MSB	LSB	LSB	MSB
Device address	Funct. Code	BYTES number	WORD 1		WORD "n"		CRC16	

The BYTES number must always match the WORDS number (in the demand) * 2.

Answer format (the demand was wrong) :

BYTE	BYTE	BYTE	LSB	MSB
Device address	Funct. Code + 0x80	Error code	CRC16	

Error codes :

- * 0x01 : Illegal Function
- * 0x02 : Illegal Data Address
- * 0x03 : Illegal Data Value

2.7. Assignments

Code 0x10 : Preset Multiple Registers (one or more Words)

Command format :

BYTE	BYTE	MSB	LSB	MSB	LSB	BYTE	MSB	LSB	MSB	LSB	LSB	MSB
Device address	Funct. Code	First WORD address		WORDS number		BYTE numbers	Word 1 Value		Word "n" Value		CRC16	

Answer format (containing data) :

BYTE	BYTE	MSB	LSB	MSB	LSB	LSB	MSB
Device address	Funct. Code	First WORD address		WORDS number		CRC16	

The BYTES number must always match the WORDS number (in the demand) * 2.

Answer format (the demand was wrong) :

BYTE	BYTE	BYTE	LSB	MSB
Device address	Function Code + 0x80	Error code	CRC16	

Error codes :

- * 0x01 : Illegal Function
- * 0x02 : Illegal Data Address
- * 0x03 : Illegal Data Value

Revisione A	M. D'Onofrio	A. Rigamonti	M. D'Onofrio
	Compilato	Controllato	Approvato

3. VARIABLES

Variables or groups of variables may be required up to 250 Bytes max.

Address	Format	Description	Unit / Note
0x100	U_WORD	Current transformer ratio (KTA)	No unit
0x102	U_WORD	Voltage transformer ratio (KTV)	1/10 (tenths)
0x104	U_WORD	Modules Configuration	(1)
0x106	U_WORD	Second decimal of Voltage transformer ratio (KTV) XXXX.Y1Y2 => Y2	
0x300	U_WORD	Model Device identifier	0x1112

Address	Format	Description	Unit / Note
0xF00	U_WORD	identifier	0x1112
0xF01	U_WORD	Hw+sw release	0x1101
0xF01	U_WORD	FC identificator	0x0

Address	Format	Description	Unit / Note
0x1000	UD_WORD	Phase 1 : phase voltage	mV
0x1002	UD_WORD	Phase 2 : phase voltage	mV
0x1004	UD_WORD	Phase 3 : phase voltage	mV
0x1006	UD_WORD	Phase 1 : current	mA
0x1008	UD_WORD	Phase 2 : current	mA
0x100a	UD_WORD	Phase 3 : current	mA
0x100c	UD_WORD	Neutral current	mA
0x100e	UD_WORD	Chained voltage : L1-L2	mV
0x1010	UD_WORD	Chained voltage : L2-L3	mV
0x1012	UD_WORD	Chained voltage : L3-L1	mV
0x1014	UD_WORD	3-phase : active power	(3)
0x1016	UD_WORD	3-phase : reactive power	(3)
0x1018	UD_WORD	3-phase : apparent power	(3)
0x101a	U_WORD	3-phase : sign of active power	(5)
0x101b	U_WORD	3-phase : sign of reactive power	(5)
0x101c	UD_WORD	3-phase : positive active energy	(4)
0x101e	UD_WORD	3-phase : positive reactive energy	(4)
0x1020	UD_WORD	3-phase : negative active energy	(4)
0x1022	UD_WORD	3-phase : negative reactive energy	(4)
0x1024	S_WORD	3-phase : power factor	1/100 signed
0x1025	U_WORD	3-phase : sector of power factor (res, cap or ind)	0=res,1=ind, 2=cap
0x1026	U_WORD	Frequency	Hz/10
0x1027	UD_WORD	3-phase : average power	(3)
0x1029	UD_WORD	3-phase : peak maximum demand	(3)
0x102b	U_WORD	Time counter for average power	minutes
0x102c	UD_WORD	Phase 1 : active power	(3)
0x102e	UD_WORD	Phase 2 : active power	(3)
0x1030	UD_WORD	Phase 3 : active power	(3)
0x1032	U_WORD	Phase 1 : sign of active power	(5)
0x1033	U_WORD	Phase 2 : sign of active power	(5)
0x1034	U_WORD	Phase 3 : sign of active power	(5)
0x1035	UD_WORD	Phase 1 : reactive power	(3)
0x1037	UD_WORD	Phase 2 : reactive power	(3)
0x1039	UD_WORD	Phase 3 : reactive power	(3)
0x103b	U_WORD	Phase 1 : sign of reactive power	(5)
0x103c	U_WORD	Phase 2 : sign of reactive power	(5)
0x103d	U_WORD	Phase 3 : sign of reactive power	(5)

Revisione A	M. D'Onofrio	A. Rigamonti	M. D'Onofrio
	Compilato	Controllato	Approvato

NEMO 96 EA ModBus

Address	Format	Description	Unit / Note
0x103e	UD_WORD	Phase 1 : apparent power	(3)
0x1040	UD_WORD	Phase 2 : apparent power	(3)
0x1042	UD_WORD	Phase 3 : apparent power	(3)
0x1044	S_WORD	Phase 1 : power factor	1/100 signed
0x1045	S_WORD	Phase 2 : power factor	1/100 signed
0x1046	S_WORD	Phase 3 : power factor	1/100 signed
0x1047	U_WORD	Phase 1 : power factor sector	0 =res, 1 =ind, 2 =cap
0x1048	U_WORD	Phase 2 : power factor sector	0 =res, 1 =ind, 2 =cap
0x1049	U_WORD	Phase 3 : power factor sector	0 =res, 1 =ind, 2 =cap
0x104a	U_WORD	Phase 1 : THD V1	% (0..100.0)
0x104b	U_WORD	Phase 2 : THD V2	% (0..100.0)
0x104c	U_WORD	Phase 3 : THD V3	% (0..100.0)
0x104d	U_WORD	Phase 1 : THD I1	% (0..100.0)
0x104e	U_WORD	Phase 2 : THD I2	% (0..100.0)
0x104f	U_WORD	Phase 3 : THD I3	% (0..100.0)
0x1050	UD_WORD	Phase 1 : I1 average	mA
0x1052	UD_WORD	Phase 2 : I2 average	mA
0x1054	UD_WORD	Phase 3 : I3 average	mA
0x1056	UD_WORD	Phase 1 : I1 peak maximum	mA
0x1058	UD_WORD	Phase 2 : I2 peak maximum	mA
0x105a	UD_WORD	Phase 3 : I3 peak maximum	mA
0x105c	UD_WORD	(I1+I2+I3)/3	mA
0x105e	UD_WORD	Phase 1 : V1 min	mV
0x1060	UD_WORD	Phase 2 : V2 min	mV
0x1062	UD_WORD	Phase 3 : V3 min	mV
0x1064	UD_WORD	Phase 1 : V1 max	mV
0x1066	UD_WORD	Phase 2 : V2 max	mV
0x1068	UD_WORD	Phase 3 : V3 max	mV
0x106a	UD_WORD	3-phase : active partial energy	(4)
0x106c	UD_WORD	3-phase : reactive partial energy	(4)
0x106e	U_WORD	Run hour meter	Hour
0x106f	U_WORD	Output relay status	(2)
0x1070	UD_WORD	3-phase : active average power	(3)
0x1072	UD_WORD	3-phase : reactive average power	(3)
0x1074	UD_WORD	3-phase : apparent average power	(3)
0x1076	UD_WORD	3-phase : active PMD power	(3)
0x1078	UD_WORD	3-phase : reactive PMD power	(3)
0x107a	UD_WORD	3-phase : apparent PMD power	(3)
0x107c	UD_WORD	Run hour meter	minutes
0x107e	UD_WORD	3-phase : Distortion Apparent Power	(3)

Address	Format	Description	Unit / Note
0x1200	U_WORD	Current transformer ratio (KTA)	No unit
0x1201	U_WORD	Voltage transformer ratio (KTV)	1/10 (tenths)
0x1202	UD_WORD	Future developments	---
0x1204	U_WORD	Device identifier	0x1112
0x1206	U_WORD	Digital Input status	0x00 I1 O I2 O 0x01 I1 C I2 O 0x02 I1 O I2 C 0x03 I1 C I2 C
0x1207	U_WORD	Voltage transformer ratio (KTV)	1/100 (hundredths)

Revisione A	M. D'Onofrio	A. Rigamonti	M. D'Onofrio
	Compilato	Controllato	Approvato

NEMO 96 EA ModBus

Address	Format	Description	Unit / Note
0x1250	UD_WORD	3-phase Positive total active energy	(4)
0x1252	UD_WORD	3-phase Positive total reactive energy	(4)
0x1254	UD_WORD	3-phase Negative total active energy	(4)
0x1256	UD_WORD	3-phase Negative total reactive energy	(4)

Address	Format	Description	Unit
0x1500	UD_WORD	3-phase : positive active energy low	Wh
0x1502	UD_WORD	3-phase : positive active energy high	MWh
0x1504	UD_WORD	3-phase : positive reactive energy low	Varh
0x1506	UD_WORD	3-phase : positive active energy high	MVarh
0x1508	UD_WORD	3-phase : negative active energy low	Wh
0x150a	UD_WORD	3-phase : negative active energy high	MWh
0x150c	UD_WORD	3-phase : negative reactive energy low	Varh
0x150e	UD_WORD	3-phase : negative active energy high	MVarh
0x1510	UD_WORD	3-phase : partial active energy low	Wh
0x1512	UD_WORD	3-phase : partial active energy high	MWh
0x1514	UD_WORD	3-phase : partial reactive energy low	Varh
0x1516	UD_WORD	3-phase : partial reactive energy high	MVarh
0x1518	SD_WORD	Signed 3-ph Active Power	W
0x151A	SD_WORD	Signed 3-ph Reactive Power	var
0x151C	SD_WORD	Signed Phase1 Active Power	W
0x151E	SD_WORD	Signed Phase2 Active Power	W
0x1520	SD_WORD	Signed Phase3 Active Power	W
0x1522	SD_WORD	Signed Phase1 Reactive Power	var
0x1524	SD_WORD	Signed Phase2 Reactive Power	var
0x1526	SD_WORD	Signed Phase3 Reactive Power	var
0x1528	SD_WORD	Signed 3-ph Power Factor	1/1000
0x152A	SD_WORD	Signed Phase1 Power Factor	1/1000
0x152C	SD_WORD	Signed Phase2 Power Factor	1/1000
0x152E	SD_WORD	Signed Phase3 Power Factor	1/1000
0x1530	UD_WORD	Apparent power	W
0x1532	UD_WORD	3-phase : active average power	W
0x1534	UD_WORD	3-phase : reactive average power	var
0x1536	UD_WORD	3-phase : apparent average power	VA
0x1538	UD_WORD	3-phase : active PMD power	W
0x153a	UD_WORD	3-phase : reactive PMD power	var
0x153c	UD_WORD	3-phase : apparent PMD power	VA
0x1540	U_WORD	positive active energy Wrap Around	
0x1541	U_WORD	positive reactive energy Wrap Around	
0x1542	U_WORD	negative active energy Wrap Around	
0x1543	U_WORD	negative reactive energy Wrap Around	
0x1544	U_WORD	apparent energy Wrap Around	
0x1580	U_WORD	Phase 1 : phase voltage crest factor	1/1000
0x1581	U_WORD	Phase 2 : phase voltage crest factor	1/1000
0x1582	U_WORD	Phase 3 : phase voltage crest factor	1/1000
0x1583	U_WORD	Phase 1 : current crest factor	1/1000
0x1584	U_WORD	Phase 2 : current crest factor	1/1000
0x1585	U_WORD	Phase 3 : current crest factor	1/1000
0x1586	U_WORD	Chained voltage : L1-L2 crest factor	1/1000
0x1587	U_WORD	Chained voltage : L2-L3 crest factor	1/1000
0x1588	U_WORD	Chained voltage : L3-L1 crest factor	1/1000
Address	Format	Description	Unit
0x1600	U_WORD	phase displacement V1-V2 (V12-V23)	0.1 °
0x1601	U_WORD	phase displacement V2-V3 (V23-V31)	0.1 °
0x1602	U_WORD	phase displacement V3-V1 (V31-V12)	0.1 °
0x1603	U_WORD	phase displacement I1-I2	0.1 °
0x1604	U_WORD	phase displacement I2-I3	0.1 °
0x1605	U_WORD	phase displacement I3-I1	0.1 °

Revisione A

M. D'Onofrio

A. Rigamonti

M. D'Onofrio

Compilato

Controllato

Approvato

NEMO 96 EA ModBus

Address	Format	Description	Unit / Note
0x1620	UD_WORD	Pulse number - input 1	
0x1622	UD_WORD	Pulse number - input 2	
0x1624	UD_WORD	Pulse number - input 3	
0x1626	UD_WORD	Pulse number - input 4	
0x1628	U_WORD	Input 1 status	0: Open 1: Close
0x162a	U_WORD	Input 2 status	0: Open 1: Close
0x162c	U_WORD	Input 3 status	0: Open 1: Close
0x162d	U_WORD	Input 4 status	0: Open 1: Close
0x1700	UD_WORD	Positive Active Energy - Low	Wh
0x1702	UD_WORD	Positive Active Energy - High	MWh
0x1704	UD_WORD	Positive Reactive Energy - Low	varh
0x1706	UD_WORD	Positive Reactive Energy - High	Mvarh
0x1708	UD_WORD	Negative Active Energy - Low	Wh
0x170A	UD_WORD	Negative Active Energy - High	MWh
0x170C	UD_WORD	Negative Reactive Energy - Low	varh
0x170E	UD_WORD	Negative Reactive Energy - High	Mvarh
0x1710	UD_WORD	Partial+ Active Energy - Low	Wh
0x1712	UD_WORD	Partial+ Active Energy - High	MWh
0x1714	UD_WORD	Partial+ Reactive Energy - Low	varh
0x1716	UD_WORD	Partial+ Reactive Energy - High	Mvarh
0x1718		NOT USED	
0x171a		NOT USED	
0x171c		NOT USED	
0x171e		NOT USED	
0x1720	SD_WORD	Signed 3-ph active power	W
0x1722	SD_WORD	Signed 3-ph reactive power	var
0x1724	SD_WORD	Signed phase1 active power	W
0x1726	SD_WORD	Signed phase2 active power	W
0x1728	SD_WORD	Signed phase3 active power	W
0x172A	SD_WORD	Signed phase1 reactive power	var
0x172C	SD_WORD	Signed phase2 reactive power	var
0x172E	SD_WORD	Signed phase3 reactive power	var
0x1730	SD_WORD	Signed 3-ph Power Factor	1/100
0x1732	SD_WORD	Signed phase1 Power Factor	1/100
0x1734	SD_WORD	Signed phase2 Power Factor	1/100
0x1736	SD_WORD	Signed phase3 Power Factor	1/100
0x1738	UD_WORD	Positive average Power Factor	1/1000
0x173a	UD_WORD	Negative average Power Factor	1/1000
0x173c	UD_WORD	Apparent Energy low	Vah
0x173e	UD_WORD	Apparent Energy high	MVah
0x1740	UD_WORD	Apparent Energy	(4)

Revisione A

M. D'Onofrio

A. Rigamonti

M. D'Onofrio

Compilato

Controllato

Approvato

NEMO 96 EA ModBus

Address	Format	Description	Unit / Note
0x1800	UD_WORD	Int. use (Vrms Half cycle phase 1)	V*100
0x1802	UD_WORD	Int. use (Vrms Half cycle phase 2)	V*100
0x1804	UD_WORD	Int. use (Vrms Half cycle phase 3)	V*100
0x180A	U_WORD	RVC Flag of phase 1	0/1
0x180B	U_WORD	RVC Flag of phase 2	0/1
0x180C	U_WORD	RVC Flag of phase 3	0/1
0x180D	U_WORD	Int. use (average Vrms Half cycle ph1 100/120 Half cycle)	V*100
0x180E	U_WORD	Int. Use (average Vrms Half cycle ph2 100/120 Half cycle)	V*100
0x180F	U_WORD	Int. Use (average Vrms Half cycle ph3 100/120 Half cycle)	V*100
0x1810	UD_WORD	$(V1+V2+V3)/3$	mV
0x1812	UD_WORD	$(V12+V23+V31)/3$	mV
0x1814	UD_WORD	$(V1_{50Hz} + V2_{50Hz} + V3_{50Hz})/3$	mV
0x1816	UD_WORD	$(V12_{50Hz} + V23_{50Hz} + V31_{50Hz})/3$	mV
0x1818	UD_WORD	One min average V1/V12	mV
0x181A	UD_WORD	One min average V2/V23	mV
0x181C	UD_WORD	One min average V3/V31	mV
0x181E	UD_WORD	Ten min average V1/V12	mV
0x1820	UD_WORD	Ten min average V2/V23	mV
0x1822	UD_WORD	Ten min average V3/V31	mV
0x1824	UD_WORD	One week average V1/V12	mV
0x1826	UD_WORD	One week average V2/V23	mV
0x1828	UD_WORD	One week average V3/V31	mV
0x182A	U_WORD	Percentage of SVC V1/V12	%
0x182B	U_WORD	Percentage of SVC V2/V23	%
0x182C	U_WORD	Percentage of SVC V3/V31	%
0x182D	U_WORD	Percentage of Unbalance	%
0x182E	UD_WORD	One min average I1	mA
0x1830	UD_WORD	One min average I2	mA
0x1832	UD_WORD	One min average I3	mA
0x1833	U_WORD	P.inst V1/V12 on ten secs(instantaneous flicker)	
0x1834	U_WORD	P.inst V2/V23 on ten secs(instantaneous flicker)	
0x1835	U_WORD	P.inst V3/V31 on ten secs(instantaneous flicker)	
0x1850	U_WORD	Day	BCD
0x1851	U_WORD	Month	BCD
0x1852	U_WORD	Year	BCD
0x1853	U_WORD	Hour	BCD
0x1854	U_WORD	Min	BCD
0x1855	U_WORD	Sec	BCD
0x1856	U_WORD	Quality calculated on Vfn/Vff	0:Vfn 1:Vff
0x1857	U_WORD	Nominal Voltage	V
0x1858	U_WORD	Dip threshold(10%-90%)	%
0x1859	U_WORD	Dip Hysteresis (%%-30%)	%
0x185A	U_WORD	Interruption threshold(10%-90%)	%
0x185B	U_WORD	Interruption Hysteresis (5%-30%)	%
0x185C	U_WORD	Swell threshold(110%-200%)	%
0x185D	U_WORD	Swell Hysteresis (5%-30%)	%
0x185E	U_WORD	SVC threshold	%
0x185F	U_WORD	RVC threshold	%

NEMO 96 EA ModBus

Address	Word #	Configuration	Note	Sw Rel
0x2000	16 U_WORD	Standard setup parameters	(*)	ALL
0x2100	24 U_WORD	Programming parameters of Module on SLOT 1	(*)	ALL
0x2200	24 U_WORD	Programming parameters of Module on SLOT 2	(*)	ALL
0x2300	24 U_WORD	Programming parameters of Module on SLOT 3	(*)	ALL

(*) -----

It is possible to read the setup parameters for each slot mounted in the device.

The data area dedicated for each slot is 24 WORDS long even if not all are used.

For instance: Pulse Output Module has three setup Parameters for each output (six for the whole Module), instead Alarm Output Module has ten setup Parameters for each output (twenty for each Module).

For each module, 24 WORDS are always transmitted : W23 | ... | W0

W23 is the first transmitted WORD and W0 the last one.

Address	Format	Description	Unit / Note
0x5000		Download Integrated data	
0x5002		Download PQ Data (Dips)	
0x5004		Download PQ Data (Interruptions)	
0x5006		Download PQ Data (Swells)	
0x5008		Download PQ Data (RVCs)	
0x5010		Download Real time data	
0x5120	U_WORD	Current date Day	BCD (1..31) *
0x5121	U_WORD	Current date month	BCD (1..12) *
0x5122	U_WORD	Current date year	BCD (0..99) *
0x5123	U_WORD	Current date Hour	BCD (0..23) *
0x5124	U_WORD	Current date minute	BCD (0..59) *
0x5125	U_WORD	Current date second	BCD (0..59) *
0x54F0	U_WORD	PQ starting download Day	BCD (1..31) *
0x54F1	U_WORD	PQ starting download month	BCD (1..12) *
0x54F2	U_WORD	PQ starting download year	BCD (0..99) *
0x54F3	U_WORD	PQ starting download Hour	BCD (0..23) *
0x54F4	U_WORD	PQ starting download minute	BCD (0..59) *
0x54F5	U_WORD	PQ starting download second	BCD (0..59) *

Address	Format	Description	Unit / Note
0x5500	U_WORD	Energy data(DI)starting download Day	BCD (1..31) *
0x5501	U_WORD	Energy data(DI)starting download month	BCD (1..12) *
0x5502	U_WORD	Energy data(DI)starting download year	BCD (0..99) *
0x5503	U_WORD	Energy data(DI)starting download Hour	BCD (0..23) *
0x5504	U_WORD	Energy data(DI)starting download minute	BCD (0..59) *
0x5505	U_WORD	Energy data(DI)starting download second	BCD (0..59) *

Address	Format	Description	Unit / Note
0x5A00	U_WORD	Real Time data(RT)starting download Day	BCD (1..31) *
0x5A01	U_WORD	Real Time data(RT)starting download Day	BCD (1..12) *
0x5A02	U_WORD	Real Time data(RT)starting download Day	BCD (0..99) *
0x5A03	U_WORD	Real Time data(RT)starting download Day	BCD (0..23) *
0x5A04	U_WORD	Real Time data(RT)starting download Day	BCD (0..59) *
0x5A05	U_WORD	Real Time data(RT)starting download Day	BCD (0..59) *

(*) -----

All of datas are R/W. Reading is available for word, Writing is possible only by block

Revisione A	M. D'Onofrio	A. Rigamonti	M. D'Onofrio
	Compilato	Controllato	Approvato

NEMO 96 EA ModBus

Address	Format	Description	Unit / Note
0x7000	U_WORD	Current phase 1 – fundamental	1000
0x7001	U_WORD	Current phase 1 - 2 nd harmonic (percentage)	1/10 %
-----	-----	-----	-----
0x7031	U_WORD	Current phase 1 - 50 th harmonic (percentage)	1/10 %
0x7040	U_WORD	Current phase 2 – fundamental	1000
0x7041	U_WORD	Current phase 2 - 2 nd harmonic (percentage)	1/10 %
-----	-----	-----	-----
0x7071	U_WORD	Current phase 2 - 50 th harmonic (percentage)	1/10 %
0x7080	U_WORD	Current phase 3 – fundamental	1000
0x7081	U_WORD	Current phase 3 - 2 nd harmonic (percentage)	1/10 %
-----	-----	-----	-----
0x70B1	U_WORD	Current phase 3 - 50 th harmonic (percentage)	1/10 %
0x70C0	U_WORD	Voltage phase 1 - fundamental	1000
0x70C1		Voltage phase 1 - 2 nd harmonic (percentage)	1/10 %
-----	-----	-----	-----
0x70F1	U_WORD	Voltage phase 1 - 50 th harmonic (percentage)	1/10 %
0x7100	U_WORD	Voltage phase 2 – fundamental	1000
0x7101	U_WORD	Voltage phase 2 - 2 nd harmonic (percentage)	1/10 %
-----	-----	-----	-----
0x7131	U_WORD	Voltage phase 2 - 50 th harmonic (percentage)	1/10 %
0x7140	U_WORD	Voltage phase 3 – fundamental	1000
0x7141	U_WORD	Voltage phase 3 - 2 nd harmonic (percentage)	1/10 %
-----	-----	-----	-----
0x7171	U_WORD	Voltage phase 3 - 50 th harmonic (percentage)	1/10 %
0x7200	UD_WORD	Current phase 1 - fundamental (rms)	mA
-----	-----	-----	-----
0x7262	UD_WORD	Current phase 1 - 50 th harmonic (rms)	mA
0x7280	UD_WORD	Current phase 2 – fundamental (rms)	mA
-----	-----	-----	-----
0x72e2	UD_WORD	Current phase 2 - 50 th harmonic (rms)	mA
0x7300	UD_WORD	Current phase 3 – fundamental (rms)	mA
-----	-----	-----	-----
0x7362	UD_WORD	Current phase 3 - 50 th harmonic (rms)	mA
0x7380	UD_WORD	Voltage phase 1 - fundamental (rms)	mV
-----	-----	-----	-----
0x73e2	UD_WORD	Voltage phase 1 - 50 th harmonic (rms)	mV
0x7400	UD_WORD	Voltage phase 2 – fundamental (rms)	mV
-----	-----	-----	-----
0x7462	UD_WORD	Voltage phase 2 - 50 th harmonic (rms)	mV
0x7480	UD_WORD	Voltage phase 3 – fundamental (rms)	mV
-----	-----	-----	-----
0x74e2	UD_WORD	Voltage phase 3 - 50 th harmonic (rms)	mV

Revisione A

M. D'Onofrio

A. Rigamonti

M. D'Onofrio

Compilato

Controllato

Approvato

NEMO 96 EA ModBus

Address	Format	Description	Unit / Note
0x7500	U_WORD	THD I1	1/10 %
0x7501	U_WORD	THD I2	1/10 %
0x7502	U_WORD	THD I3	1/10 %
0x7503	U_WORD	THD V1	1/10 %
0x7504	U_WORD	THD V2	1/10 %
0x7505	U_WORD	THD V3	1/10 %

3.1. Notes

(1) -----

Variable			
MSB BYTE 3	BYTE 2	BYTE 1	LSB BYTE 0
Slot 3	Slot 2	Slot 1	Slot 0

Type of slot :

' ' : NO MODULE

'A' : RS485

'b' : PULSES OUT

'C' : ALARMS OUT

'd' : ANALOG OUT

'E' : NEUTRAL CURRENT

'F' : I/O MODULE

'h' : TEMPERATURE

(2) -----

Device programmed in "Alarm Output" mode :

0: No active Alarm

1: Alarm active

(3) -----

W, var, VA / 100 if $KTA \cdot KTV < 5000$

W, var, VA if $KTA \cdot KTV \geq 5000$

(4) -----

Transformer ratio	Measurement unit	Display Format	Protocol Format
$1 \leq KTA \cdot KTV < 10$	Wh(varh) * 10	xxxxxx.yy k	xxxxxxyy
$10 \leq KTA \cdot KTV < 100$	Wh(varh) * 100	xxxxxxx.y k	xxxxxxxxy
$100 \leq KTA \cdot KTV < 1000$	kWh(kvarh)	xxxxxxx k	xxxxxxx
$1000 \leq KTA \cdot KTV < 10000$	kWh(kvarh) * 10	xxxxxx.yy M	xxxxxxyy
$10000 \leq KTA \cdot KTV < 100000$	kWh(kvarh) * 100	xxxxxxx.y M	xxxxxxxxy
$100000 \leq KTA \cdot KTV$	kWh(kvarh) * 100	xxxxxxx M	xxxxxxx

(5) -----

0 : positive

1 : negative

Revisione A	M. D'Onofrio	A. Rigamonti	M. D'Onofrio
	Compilato	Controllato	Approvato

IME 	COMMUNICATION PROTOCOL	PR 150	Rev. A
		31/01/2018	Pag 15
Multifunction		Firmware ≥ 1.101	
NEMO 96 EA ModBus			

4. Setup parameters remote settings, Resets and Programming

NEMO 96 EA parameters may be read and written accordingly to the procedure described in the following.

Master Unlock KeyWriting

Every write operation must be preceded by a "Master Unlock Key" command.

Address 0x2700 : write word with value = 0x5AA5 (Master Unlock Key)

Reset of NEMO 96 EA

Any writing operation of any parameter will have effect only in the volatile memory (RAM).

After any writing operation of parameters described in the following of the document, if necessary to go back to the default then it is mandatory to send the following commands :

Address 0x2700 : write word with value = 0x5AA5 (Master Unlock Key)

Address 0x2800 : write word with value = 0xYYYY (any value)

This command will reset the NEMO 96 EA and in this way all changes will be lost so returning to the previous conditions.

EEPROM savings

If it is necessary to save the new parameters in EEPROM, it is mandatory to send these following messages :

Address 0x2700 : write word with value = 0x5AA5 (Master Unlock Key)

Address 0x2600 : write word with value = 0xYYYY (any value)

ADDRESS TABLE

Address	Format	Description	Value / Note
0x100	WORD	Write Current transform ratio	1 - 9999
0x102	WORD	Write Voltage transform ratio	(7)
0x106	WORD	Write Second Decimal of Voltage transform ratio	
0x2000	16 WORD	Write Standard setup parameters	(6)
0x2100	24 WORD	Write Programming parameters of Module on SLOT 1	(6)
0x2200	24 WORD	Write Programming parameters of Module on SLOT 2	(6)
0x2300	24 WORD	Write Programming parameters of Module on SLOT 3	(6)
0x2400	WORD	Reset Hour Meter, Maximum Powers, Maximum Voltages, Maximum Currents, Minimum Voltages, Active Partial Energy, Reactive Partial Energy	(8)
0x2600	WORD	Saving in EEPROM parameters changed by Remote commands	(9)
0x2700	WORD	Enable Remote Writing Operation (master Unlock Key)	(10)
0x2800	WORD	Load previous setup parameters stored in EEPROM	(11)

This value is in V/10

For instance, write 50 to have KTV = 5.0

To reset desired measurements write the following word (in binary) :

x	x	x	x	x	x	x	x	x	x	x	b6	b5	b4	b3	b2	b1	b0
---	---	---	---	---	---	---	---	---	---	---	----	----	----	----	----	----	----

b0 =1 Reset Hour Meter

b1 =1 Reset Maximum Powers

b2 =1 Reset Maximum Voltages

b3 =1 Reset Maximum Currents

b4 =1 Reset Minimum Voltages

b5 =1 Reset Active Partial Energy

b6 =1 Reset Reactive Partial Energy

b7 .. b15 = 0

Write any value to save the new parameters changed by Remote commands

To do any remote programming write operation, it's mandatory to write a safety key = 0x5AA5.

Write any value to abort any remote programming write operation and go back to previous values.

Revisione A	M. D'Onofrio	A. Rigamonti	M. D'Onofrio
	Compilato	Controllato	Approvato

5. Pulse Output Module – IF96003

All the values in this section must be read through a multiple registers and written using a preset multiple register function. It is not possible to read and assign 1 single parameter. All the words are of the R/W type.

x	x	x	x	x	x	x	x	x	x	x	x	x	x	x	x	x	x	W 5	W 4	W 3	W 2	W 1	W 0
void																	Out 2			Out 1			

W0 and W3 0 = Positive Active Energy
 1 = Positive Reactive Energy
 2 = Negative Active Energy
 3 = Negative Reactive Energy

W1 and W4 0 = Pulse Weight 0.01 K
 1 = Pulse Weight 0.1 K
 2 = Pulse Weight 1.0 K
 3 = Pulse Weight 10.0 K
 4 = Pulse Weight 100.0 K
 5 = Pulse Weight 1.0 M
 6 = Pulse Weight 10.0 M

W2 and W5 0 = Pulse Duration 50 mS
 1 = Pulse Duration 100 mS
 2 = Pulse Duration 200 mS
 3 = Pulse Duration 300 mS

Note : x means that this word value is without meaning.

6. Twin Alarm OUT module - IF96005

All the values in this section must be read through a multiple registers and written using a preset multiple register function. It is not possible to read and assign 1 single parameter. All the words are of the R / W type.

x	x	x	x	W 19	W 18	W 17	W 16	W 15	W 14	W 13	W 12	W 11	W 10	W 9	W 8	W 7	W 6	W 5	W 4	W 3	W 2	W 1	W 0
void				Alarm 2 - Out 2										Alarm 1 - Out 1									

W0 and W10 0 = Alarm on V phase 1
 1 = Alarm on V phase 2
 2 = Alarm on V phase 3
 3 = Alarm on I phase 1
 4 = Alarm on I phase 1K
 5 = Alarm on I phase 1
 6 = Alarm on V phase 12
 7 = Alarm on V phase 23
 8 = Alarm on V phase 31
 9 = Alarm on P phase 1
 10 = Alarm on P phase 2
 11 = Alarm on P phase 3
 12 = Alarm on Q phase 1
 13 = Alarm on Q phase 2
 14 = Alarm on Q phase 3
 15 = Alarm on P three phase
 16 = Alarm on Q three phase
 17 = Alarm on PF three phase

Revisione A	M. D'Onofrio	A. Rigamonti	M. D'Onofrio
	Compilato	Controllato	Approvato

NEMO 96 EA ModBus

- 18 = Alarm on Frequency
- 19 = Alarm on P Active Power Demand
- 20 = Alarm on P reactive Power Demand
- 21 = Alarm on Current SUM
- 22 = Alarm on Temperature Ch.1
- 23 = Alarm on Temperature Ch.2
- 24 = Alarm on Neutral current

- W1 and W11 0 = Sign + for Set Point
1 = - for Set Point (Possible only for Powers)
- W2 and W12 0 = Decimal Point Position X.XXX
1 = Decimal Point Position XX.XX
2 = Decimal Point Position XXX.X
- W3 and W13 0 = kilo for Powers (Inductive for PF)(V for Voltages)
(A for Currents) (Hz for Frequency)
1 = Mega for Powers (Capacitive for PF)(kV for Voltages)
(kA for Currents) (Hz for Frequency)
- W4 and W14 0 = 0 - 9999 => Value of the Set Point (threshold)
- W5 and W15 0 = Alarm active when Lower than Setpoint
1 = Alarm active when Higher than Setpoint
2 = Decimal Point Position XXX.X
- W6 and W16 0 = Relay Normally Open
1 = Relay Normally Close
- W7 and W17 0 .. 10 = 0..10% Hysteresys of Set point (configurable value)
11 = 15% Hysteresys of Set point
12 = 20% Hysteresys of Set point
- W8 and W18 0..99 Alarm activation delay (Seconds)
- W9 and W19 0..99 Alarm de-activation delay (Seconds)

Note : x means that this word value is without meaning.

7. Twin Analogue OUT module – IF96004

All the values in this section must be read through a multiple registers and written using a preset multiple register function. It is not possible to read and assign 1 single parameter. All the words are of the R / W type.

x	x	x	x	W	W	W	W	W	W	W	W	W	W	W	W	W	W	W	W	W	W	W	W
void				Analog Out 2										Analog Out 1									

- W0 and W10 0 = Range 4..20 mA
1 = Range 0..20 mA
- W1 and W11 0 = Transduce Measure V phase 1
1 = Transduce Measure V phase 2
2 = Transduce Measure V phase 3
3 = Transduce Measure I phase 1
4 = Transduce Measure I phase 1
5 = Transduce Measure I phase 1

Revisione A	M. D'Onofrio	A. Rigamonti	M. D'Onofrio
	Compilato	Controllato	Approvato

NEMO 96 EA ModBus

- 6 = Transduce Measure V 12
- 7 = Transduce Measure V 23
- 8 = Transduce Measure V 31
- 9 = Transduce Measure P phase 1
- 10 = Transduce Measure P phase 2
- 11 = Transduce Measure P phase 3
- 12 = Transduce Measure Q phase 1
- 13 = Transduce Measure Q phase 2
- 14 = Transduce Measure Q phase 3
- 15 = Transduce Measure P three phase
- 16 = Transduce Measure Q three phase
- 17 = Transduce Measure PF three phase
- 18 = Transduce Measure Frequency
- 19 = Transduce Measure Active Power Demand
- 20 = Transduce Measure Reactive Power Demand
- 21 = Transduce Measure Current SUM
- 22 = Transduce Measure Temperature ch.1
- 23 = Transduce Measure Temperature ch.2
- 24 = Transduce Measure Neutral Current

W2 and W12 0 = Sign + for Begin Scale
1 = Sign - for Begin Scale

W3 and W13 0 = Decimal Point Position X.XXX
1 = Decimal Point Position XX.XX
2 = Decimal Point Position XXX.X

W4 and W14 0 = kilo for Powers (Inductive for PF)(V for Voltages)
(A for Currents) (Hz for Frequency)
1 = Mega for Powers (Capacitive for PF)(kV for Voltages)
(kA for currents kA for Currents) (Hz for Frequency)

W5 and W15 0.. 9999 as value for Begin Scale

W6 and W16 0 = Sign + for End Scale
1 = Sign - for End Scale

W7 and W17 0 = Decimal Position X.XXX
1 = Decimal Position XX.XX
2 = Decimal Position XXX.X

W8 and W18 0 = kilo for Powers (Inductive for PF)(V for Voltages)
(A for Currents) (Hz for Frequency)
1 = Mega for Powers (Capacitive for PF)(kV for Voltages)
(kA for Currents)(Hz for Frequency)

W9 – W19 0.. 9999 as value for End Scale

Note : x means that this word value is without meaning.

8. Neutral Current module - IF96006

All the values in this section must be read through a multiple registers and written using a preset multiple register function. It is not possible to read and assign 1 single parameter. All the words are of the R / W type.

x	x	x	x	x	x	x	x	x	x	x	x	x	x	x	x	x	x	x	x	x	x	x	W
																							0

Revisione A		M. D'Onofrio	A. Rigamonti	M. D'Onofrio
		Compilato	Controllato	Approvato

	COMMUNICATION PROTOCOL	PR 150	Rev. A
		31/01/2018	Pag 19
Multifunction		Firmware ≥ 1.101	
NEMO 96 EA ModBus			

W0 1..9999 Current transformer Ratio for Neutral Current Module

Value Reading

The value of the neutral current is given back at the same address where In is in all tables.

Note : x means that this word value is without meaning.

9. I/O module - IF96010 / IF96011

Functions

- (in) pulse counter - input status
- (in) pulse counter - reset
- (out) remote relay - control
- (out) remote relay - control and setting
- (out) alarm out - setting
- (in) tariffs management - setting
- (in) tariffs management - reading

Address	Format	Description	Note	Position
0x03F0	UD_WORD	Pulse counting 1 on I/O Module	1	Slot 2
0x03F4	UD_WORD	Pulse counting 2 on I/O Module	1	Slot 2
0x03F8	UD_WORD	Pulse counting 3 on I/O Module	1	Slot 3
0x03FC	UD_WORD	Pulse counting 4 on I/O Module	1	Slot 3
0x0400	U_WORD	Status of input 1 on I/O Module	2	Slot 2
0x0401	U_WORD	Status of input 2 on I/O Module	2	Slot 2
0x0402	U_WORD	Status of input 3 on I/O Module	2	Slot 3
0x0403	U_WORD	Status of input 4 on I/O Module	2	Slot 3
0x0510	U_WORD	Code to reset one Pulse Counting		
0x2700	U_WORD	Enable Remote Writing Operation		
0x106f	U_WORD	To open or close relays on IO Module		

9.1.Pulse counting – Input status

Pulse counting : example for a NEMO 96 EA with address 255 (0xFF) asking input 4 counting :
Request FF | 03 | 03 | FC | 00 | 02 | 11 | A1

Answer FF | 03 | 04 | 00 | 00 | 00 | 0B | A4 | 3B

This means that the Pulse Counter has counted 11 (0x0000000B) pulses.

Input status : example for a NEMO96 EA with address 255 (0xFF) asking input 2 status :
Request FF | 03 | 04 | 01 | 00 | 01 | C1 | 24

Answer FF | 03 | 02 | 00 | 00 | 91 | 90

This means that 00 | 00 is the value that indicates OPEN (otherwise 00 | 01 for CLOSED).

Note:

- (1) -----
Wrap around at 100.000.000
- (2) -----
0 = Open ; 1 = Closed

Revisione A	M. D'Onofrio	A. Rigamonti	M. D'Onofrio
	Compilato	Controllato	Approvato

	COMMUNICATION PROTOCOL	PR 150	Rev. A
		31/01/2018	Pag 20
Multifunction		Firmware ≥ 1.101	
NEMO 96 EA ModBus			

9.2.Pulse counters - reset

Example for a NEMO 96 EA with address 255 (0xFF):

1° writing to take control of remote operations.

Command: FF | 10 | 27 | 00 | 00 | 01 | 02 | 5A | A5 | 43 | ED

Answer: FF | 10 | 27 | 00 | 00 | 01 | 1E | A3

2° writing

Command: FF | 10 | 05 | 10 | 00 | 01 | 02 | RESET | C1 | C2

Answer: FF | 10 | 05 | 10 | 00 | 00 | D4 | DE

RESET 0x0010 Reset of Pulse Counter 1 on Slot 2
 0x0001 Reset of Pulse Counter 2 on Slot 2
 0x1000 Reset of Pulse Counter 1 on Slot 3
 0x0100 reset of Pulse Counter 2 on Slot 3

3° writing to set relays on I/O Module

Command: FF | 10 | 10 | 6F | 00 | 01 | 02 | Relay Output | C1 | C2

Answer: FF | 10 | 10 | 6F | 00 | 01 | 20 | CA

Depending on bitmap RELAY OUTPUT we have the following relays setting in binary format :

Relay Output:	b 0000xxx1	Relay 1 Close on Slot 2
	b 0000xx1x	Relay 2 Close on Slot 2
	b 0000x1xx	Relay 1 Close on Slot 3
	b 00001xxx	Relay 2 Close on Slot 3
	b 0000xxx0	Relay 1 Open on Slot 2
	b 0000xx0x	Relay 2 Open on Slot 2
	b 0000x0xx	Relay 1 Open on Slot 3
	b 0000x000	Relay 2 Open on Slot 3

Note:

in the binary format value the "x", represents the previous state that is to be maintained

Revisione A	M. D'Onofrio	A. Rigamonti	M. D'Onofrio
	Compilato	Controllato	Approvato

	COMMUNICATION PROTOCOL	PR 150	Rev. A
		31/01/2018	Pag 21
Multifunction		Firmware ≥ 1.101	
NEMO 96 EA ModBus			

9.3. Alarm out - setting

All the values in this section must be read through a multiple registers and written using a preset multiple register function. It is not possible to read and assign 1 single parameter. All the words are of the R / W type.

W 23	W 22	W 21	W 20	W 19	W 18	W 17	W 16	W 15	W 14	W 13	W 12	W 11	W 10	W 9	W 8	W 7	W 6	W 5	W 4	W 3	W 2	W 1	W 0
Alarm2 - Out 2												Alarm1 - Out 1											

- W0 and W12 0 = output Relay as Alarm
1 = output Relay as Remote Bistable contact
2 = output Relay as Remote Timed contact
- W1 and W13 0 = Alarm on V phase 1
1 = Alarm on V phase 2
2 = Alarm on V phase 3
3 = Alarm on I phase 1
4 = Alarm on I phase 1K
5 = Alarm on I phase 1
6 = Alarm on V phase 12
7 = Alarm on V phase 23
8 = Alarm on V phase 31
9 = Alarm on P phase 1
10 = Alarm on P phase 2
11 = Alarm on P phase 3
12 = Alarm on Q phase 1
13 = Alarm on Q phase 2
14 = Alarm on Q phase 3
15 = Alarm on P three phase
16 = Alarm on Q three phase
17 = Alarm on PF three phase
18 = Alarm on Frequency
19 = Alarm on P Active Power Demand
20 = Alarm on P reactive Power Demand
21 = Alarm on Current SUM
22 = Alarm on Temperature Ch.1
23 = Alarm on Temperature Ch.2
24 = Alarm on Neutral current
- W2 and W14 0 = Sign + for Set Point
1 = - for Set Point (Possible only for Powers)
- W3 and W15 0 = Decimal Point Position X.XXX
1 = Decimal Point Position XX.XX
2 = Decimal Point Position XXX.X
- W4 and W16 0 = kilo for Powers (Inductive for PF)(V for Voltages)
(A for Currents) (Hz for Frequency)
1 = Mega for Powers (Capacitive for PF)(kV for Voltages)
(kA for Currents) (Hz for Frequency)
- W5 and W17 0 = 0 - 9999 => Value of the Set Point (threshold)
- W6 and W18 0 = Alarm active when Lower than Setpoint
1 = Alarm active when Higher than Setpoint
2 = Decimal Point Position XXX.X
- W7 and W19 0 = Relay Normally Open
1 = Relay Normally Close

Revisione A	M. D'Onofrio	A. Rigamonti	M. D'Onofrio
	Compilato	Controllato	Approvato

NEMO 96 EA ModBus

W8 and W20 0 .. 10 = 0..10% Hysteresys of Set point (configurable value)
 11 = 15% Hysteresys of Set point
 12 = 20% Hysteresys of Set point

W9 and W21 0..99 Alarm activation delay (Seconds)

W10 and W22 0..99 Alarm de-activation delay (Seconds)

W11 0 Always

W23 0 = Counting / Tariff input selector
 1 = Counting / Tariff selector

Tariffs management - settings

1° reading of 24 WORDS to get current settings

2° writing to enable remote operations

Command : FF | 10 | 27 | 00 | 00 | 01 | 02 | 5A | A5 | 43 | ED

Answer : FF | 10 | 27 | 00 | 00 | 01 | 1E | A3

3° writing of 24 WORDS to set the tariffs modality – only W23 changed W23 => pulse counting / tariff input selector

0 => pulse counting

1 => tariff selector

Warning :

Input for tariff selection metering - only input 1 of the module in slot 2 e.g.

if module on slot 2 => input 1

if module on slot 3 => not possible

if both modules => only input 1 of module on slot 2

Tariffs management - readings

Address	Format	Description	Unit / Note
0x101c	UDWORD	Tariff 1 : positive active energy	See standard table
0x101e	UDWORD	Tariff 1 : positive reactive energy	See standard table
0x106a	UDWORD	Tariff 2 : active partial energy	See standard table
0x106c	UDWORD	Tariff 2 : reactive partial energy	See standard table

10. Double Temperature measurement module - IF96016

Available only on slot 3

2 Unsigned Double Word for variables value

2 Word containing the sign of variables

Address	Format	Description	Unit	SW version
0x03F8	UDWORD	Temperature First Channel	°C/100	≥ 1.100
0x03FC	UDWORD	Temperature Second Channel	°C/100	≥ 1.100
0x0402	WORD	Sign Temperature First Channel	0(+)/1(-)	≥ 1.100
0x0403	WORD	Sign Temperature Second Channel	0(+)/1(-)	≥ 1.100

Revisione A	M. D'Onofrio	A. Rigamonti	M. D'Onofrio
	Compilato	Controllato	Approvato

11. Standard Programming Parameters

All the values in this section must be read through a multiple registers and written using a preset multiple register function. It is not possible to read and assign 1 single parameter. All the words are of the R / W type.

x	x	x	x	W 11	W 10	W 9	W 8	W 7	W 6	W 5	W 4	W 3	W 2	W 1	x
---	---	---	---	---------	---------	--------	--------	--------	--------	--------	--------	--------	--------	--------	---

W1 = custom page - line 1 (for all wirings)
 W2 = custom page - line 2 (for all wirings)
 W3 = custom page - line 3 (for all wirings)
 W4 = wiring
 W5 = average time calculation
 W6 = display contrast
 W7 = backlight intensity
 W8 = nominal current
 W9 = max harmonics number to show on display

W1 = 0 => V phase 1
 1 => V chained 12
 2 => I phase 1
 3 => I Neutral
 4 => P 3-phase
 5 => Q 3-phase
 6 => S 3-phase
 7 => P phase 1
 8 => Q phase 1
 9 => S phase 1
 10 => PF 3-phase

W2 = 0 => V phase 2
 1 => V chained 23
 2 => I phase 2
 3 => P 3-phase
 4 => Q 3-phase
 5 => S 3-phase
 6 => P phase 2
 7 => Q phase 2
 8 => S phase 2
 9 => Frequency
 10 => I phase 1

W3 = 0 => V phase 3
 1 => V chained 31
 2 => I phase 3
 3 => P 3-phase
 4 => Q 3-phase
 5 => S 3-phase
 6 => P phase 3
 7 => Q phase 3
 8 => S phase 3
 9 => P phase 1
 10 => I phase 1

W4 = 0 => 3N3E
 1 => 3-3E
 2 => 3-2E
 3 => 1N1E
 4 => 3N1E
 5 => 3-1E

Revisione A	M. D'Onofrio	A. Rigamonti	M. D'Onofrio
	Compilato	Controllato	Approvato

NEMO 96 EA ModBus

- W5 = 0 => 5 minutes
 1 => 8 minutes
 2 => 10 minutes
 3 => 15 minutes
 4 => 20 minutes
 5 => 30 minutes
 6 => 60 minutes
- W6 = 0 => Level 0
 1 => Level 1
 2 => Level 2
 3 => Level 3
- W7 = 0 => 0 %
 1 => 30 %
 2 => 70 %
 3 => 100 %
- W8 = 0 => 5 A
 1 => 1 A
- W9 = 0 => up to 9[^] harmonic
 1 => up to 25[^] harmonic
- W10 = 0 => Voltage Phase 1 greater than 20 V
 1 => Power 3-Phase greater than X % of Nominal Power (3*230V*5A = 3450 W)
- W11 = X % only if W10 = 1

Reading Example

Demand of 4 WORDS (8 BYTES – 2 variables) starting from the address 0x0101C to device 1 :

Node Address	F. Code	Register Address		Words number		CRC 16	
byte	byte	MSB	LSB	MSB	LSB	LSB	MSB
0x01	0x03	0x10	0x1C	0x00	0x04	0x81	0x0F

Answer

Node Address	F. Code	Byte Num.	Word 1		Word 2		Word 3		Word 4		CRC 16	
byte	byte	byte	MSB	LSB	MSB	LSB	MSB	LSB	MSB	LSB	LSB	MSB
0x01	0x03	0x08	0x00	0x00	0x64	0x8C	0x00	0x00	0x35	0x54	0x9A	0x83

In the above case, the information is :

WORD 1, WORD 2 : Positive active energy 0x0000648C = 25740

WORD 3, WORD 4 : Positive reactive energy 0x00003554 = 13652

12. Remote Reset and Programming

Data are written at the same way as they are read. The WORD sequence is the same.

In writing the messages sequence is :

- 1) Write word 0x5AA5 to address 0x2700
- 2) Write the number of necessary WORDS at the address where the standard parameters or the module variables are mapped

Warning

That parameters will be changed only in volatile memory.

Revisione A	M. D'Onofrio	A. Rigamonti	M. D'Onofrio
	Compilato	Controllato	Approvato

If it is necessary to go back to the old parameters saved in EEPROM, it is mandatory to send also these following messages :

- 1) write word 0x**5AA5** to address 0x**2700**
- 2) write word 0x**YYYY** to address 0x**2800** (Y = any value)

If it is necessary to **save** new parameters in **EEPROM** it is mandatory to send these following messages :

- 1) Write word 0x**5AA5** to address 0x**2700**
- 2) write word 0x**YYYY** to address 0x**2600** (Y = any value)

13. Historic Write Address Table

Address	word n.	Description	Example
0x5120	6	Current date and time	(1)
0x5140	3	Saving Real Time interval period and record data type	(2)
0x5500	6	Initial date and time for energy data reading	(3)
0x5510	6	Date and time for start of Daylight Saving Time period	(4)
0x5520	6	Date and time for end of Daylight Saving Time period	(5)
0x5A00	6	Initial date and time for real time data reading	(6)
0x5000	XX	Energy stored data page reading	(7)
0x5010	XX	Real Time Stored data page reading	(8)
0x3700		Real time measurements : free registers bit map	

Note:

DEV = Device's ModBus Node Address
 The format of date and time data are in BCD format

Example:

1. Current date and time reading :

Request DEV 03 **51 20** 00 06 CRC_L CRC_H

Answer DEV 03 0C **00 02 00 01 00 00 00 02 00 46 00 35** CRC_L CRC_H (**02/01/00 02:46:35**)

2. Saving interval period for Real Time data and Energy data and record data type reading :

Request DEV 03 **51 40** 00 03 CRC_H CRC_L

Answer DEV 03 06 **00 01 00 00 00 00** CRC_H CRC_L (**5 seconds Type 0 5minutes**)

Real Time interval period		Record data type		Energy interval period	
Reading Value	Meaning	Reading Value	Meaning	Reading Value	Meaning
00 00	2 sec	00 00	Type 0	00 00	5 min
00 01	5 sec	00 01	Type 1	00 01	10 min
00 02	10 sec	00 02	Type 2	00 02	15 min
00 03	30 sec	00 03	Type 3		
00 04	60 sec	00 04	Type 4		
00 05	2 min				
00 06	5 min				
00 07	10 min				

- (3) Date and time of the first record of integrated data (energies and average powers) :

Request DEV 03 **55 00** 00 06 CRC_H CRC_L

Answer DEV 03 0C **00 01 00 01 00 00 00 00 00 00 00 00** CRC_H CRC_L (**01/01/00 00:00:00**)

- (4) Date and time of start of Daylight Saving Time period :

Request DEV 03 **55 10** 00 06 C0 1F

Answer DEV 03 0C **00 29 00 03 00 09 00 03 00 00 00 00** CRC_H CRC_L (**29/03/09 03:00:00**)

Revisione A	M. D'Onofrio	A. Rigamonti	M. D'Onofrio
	Compilato	Controllato	Approvato

	COMMUNICATION PROTOCOL	PR 150	Rev. A
		31/01/2018	Pag 26
Multifunction		Firmware ≥ 1.101	
NEMO 96 EA ModBus			

(5) Date and time of end of Daylight Saving Time period :

Request DEV 03 **55 20** 00 06 CRC_L CRC_H
Answer DEV 03 0C **00 25 00 10 00 09 00 02 00 00 00 00** CRC_H CRC_L (**25/10/09 02:00:00**)

Writing a daylight saving time will be saved on the first Sunday of the month if the date written is before the 15th, will be the last Sunday of the month if the date written is after the 15th.

(6) Date and time of the first record of real time data (voltages, currents etc.) reading :

Request DEV 03 **5A 00** 00 06 CRC_L CRC_H
Answer DEV 03 0C **00 01 00 01 00 00 00 00 00 00 00 00** CRC_H CRC_L (**01/01/00 00:00:00**)

(7) Energy stored data reading:

Request DEV 03 **50 00** 00 01 CRCH CRCL
Answer DEV 03 F0 + all follow byte

05 12 18 Date for current record n
12 35 00 Time for current record n
00 BC 64 0F Active Positive Energy
01 65 ED CE Reactive Positive Energy
02 0F 77 FA Active Negative Energy
02 B9 02 5F Reactive Negative Energy
00 00 03 1d Average Power
00 00 04 af Max Power Demand

..... etc etc....

05 12 18 Date for current record n
12 42 00 Time for current record n
00 BC 64 0F Active Positive Energy
01 65 ED CE Reactive Positive Energy
02 0F 77 FA Active Negative Energy
02 B9 02 5F Reactive Negative Energy
00 00 03 1d Average Power
00 00 04 af Max Power Demand
CRC_L CRC_H

(8) Energy data page reading :

Request DEV 03 **50 00** 00 00 CRC_L CRC_H
Answer DEV 03 F0 + all follow byte

18 06 09 Data of current record n
13 50 00 Time of current record n
00 01 D5 88 Active Positive Energy
00 02 BE 58 Active Negative Energy
00 03 5A FC Reactive Positive Energy
00 00 01 84 Reactive Negative Energy
00 00 03 1D Average Power
00 00 04 AF Maximum Power Demand

18 06 09 Data for current record n+1
14 05 00 Time for current record n+1
00 01 D5 88 Active Positive Energy
00 02 BE 58 Active Negative Energy
00 03 5A FC Reactive Positive Energy
00 00 01 84 Reactive Negative Energy
00 00 03 1D Average Power
00 00 04 AF Maximum Power Demand

Revisione A	M. D'Onofrio	A. Rigamonti	M. D'Onofrio
	Compilato	Controllato	Approvato

NEMO 96 EA ModBus

18 06 09 Data for current record n+2
 14 20 00 Time for current record n+2
 00 01 D5 88 Active Positive Energy
 00 02 BE 58 Active Negative Energy
 00 03 5A FC Reactive Positive Energy
 00 00 01 84 Reactive Negative Energy
 00 00 03 1D Average Power
 00 00 04 AF Maximum Power Demand

18 06 09 Data for current record n+3
 14 35 00 Time for current record n+3
 00 01 D5 88 Active Positive Energy
 00 02 BE 58 Active Negative Energy
 00 03 5A FC Reactive Positive Energy
 00 00 01 84 Reactive Negative Energy
 00 00 03 1D Average Power
 00 00 04 AF Maximum Power Demand

18 06 09 Data for current record n+4
 14 50 00 Time for current record n+4
 00 01 D5 88 Active Positive Energy
 00 02 BE 58 Active Negative Energy
 00 03 5A FC Reactive Positive Energy
 00 00 01 84 Reactive Negative Energy
 00 00 03 1D Average Power
 00 00 04 AF Maximum Power Demand

18 06 09 Data for current record n+5
 13 51 33 Time for current record n+5
 00 01 D5 88 Active Positive Energy
 00 02 BE 58 Active Negative Energy
 00 03 5A FC Reactive Positive Energy
 00 00 01 84 Reactive Negative Energy
 00 00 03 1D Average Power
 00 00 04 AF Maximum Power Demand

18 06 09 Data for current record n+6
 15 05 00 Time for current record n+6
 00 01 D5 88 Active Positive Energy
 00 02 BE 58 Active Negative Energy
 00 03 5A FC Reactive Positive Energy
 00 00 01 84 Reactive Negative Energy
 00 00 03 1D Average Power
 00 00 04 AF Maximum Power Demand

18 06 09 Data for current record n+7
 15 20 00 Time for current record n+7
 00 01 D5 88 Active Positive Energy
 00 02 BE 58 Active Negative Energy
 00 03 5A FC Reactive Positive Energy
 00 00 01 84 Reactive Negative Energy
 00 00 03 1D Average Power
 00 00 04 AF Maximum Power Demand
 CRC_L CRC_H

13.3. Historic Set and Reset

Address	Word N°	Description	Example
0x5142	1	Saving energy data interval	(9)
0x54F0	6	Initial date and time for Power Quality data	(10)
0x5B00	4	Reset all energy data memory	(11)
0x5C00	4	Reset all real time data memory	(12)
0x5D00	4	Reset all Power quality data memory	(13)

Example : write the right number of bytes to any address otherwise errors can occur.

(9) Saving energy data interval (5 minutes) :

Command DEV 10 51 42 00 01 02 00 00 CRC_LCRC_H
 Answer DEV 10 51 42 00 01 CRC_LCRC_H

Writing Value	Meaning
00 00	5 min
00 01	10 min
00 02	15 min

(10) Initial date and time for integrated data (energies and average powers) (17/06/09 12:11:47) :

Command DEV 10 54 F0 00 06 0C 00 17 00 06 00 09 00 12 00 11 00 47 CRC_LCRC_H
 Answer DEV 10 54 F0 00 06 CRC_LCRC_H

(11) Reset all energy data memory :

Command DEV 10 5B 00 00 04 08 52 65 73 65 74 4D 65 6D CRC_LCRC_H
 Answer DEV 10 5B 00 00 04 CRC_LCRC_H

(12) Reset all real time data memory :

Command DEV 10 5C 00 00 04 08 52 65 73 65 74 44 61 64 CRC_LCRC_H
 Answer DEV 10 5C 00 00 04 CRC_LCRC_H

(13) Reset all power quality data memory :

Command DEV 10 5D 00 00 04 08 52 65 73 65 74 44 61 64 CRC_LCRC_H
 Answer DEV 10 5D 00 00 04 CRC_LCRC_H

Revisione A	M. D'Onofrio	A. Rigamonti	M. D'Onofrio
	Compilato	Controllato	Approvato

13.4. Historic Data record types
Type 0

Type	Description	Unit
UDWord	Phase 1 : phase voltage	mV
UDWord	Phase 2 : phase voltage	mV
UDWord	Phase 3 : phase voltage	mV
UDWord	Phase 1 : current	mA
UDWord	Phase 2 : current	mA
UDWord	Phase 3 : current	mA
UDWord	Neutral current	mA
UDWord	Chained voltage : L1-L2	mV
UDWord	Chained voltage : L2-L3	mV
UDWord	Chained voltage : L3-L1	mV
UDWord	3-phase : active power	
UDWord	3-phase : reactive power	
UDWord	3-phase : apparent power	
Word	3-phase : power factor	1/100
Word	3-phase : sector of power factor (cap or ind)	1 : ind 2 : cap
Word	Frequency	Hz/10
UDWord	Phase 1 : active power	
UDWord	Phase 2 : active power	
UDWord	Phase 3 : active power	
UDWord	Phase 1 : reactive power	
UDWord	Phase 2 : reactive power	
UDWord	Phase 3 : reactive power	
Word	Phase 1 : power factor	1/100
Word	Phase 2 : power factor	1/100
Word	Phase 3 : power factor	1/100
Word	Phase 1 : power factor sector	1 : ind 2 : cap
Word	Phase 2 : power factor sector	1 : ind 2 : cap
Word	Phase 3 : power factor sector	1 : ind 2 : cap
Word	Phase 1 : THD V1	%
Word	Phase 2 : THD V2	%
Word	Phase 3 : THD V3	%
Word	Phase 1 : THD I1	%
Word	Phase 2 : THD I2	%
Word	Phase 3 : THD I3	%
Word	Output relay status	

NEMO 96 EA ModBus
Type 1

Type	Description	Unit
UDWord	Phase 1 : phase voltage	mV
UDWord	Phase 2 : phase voltage	mV
UDWord	Phase 3 : phase voltage	mV
UDWord	Phase 1 : current	mA
UDWord	Phase 2 : current	mA
UDWord	Phase 3 : current	mA
UDWord	Neutral current	mA
UDWord	3-phase : active power	
UDWord	3-phase : reactive power	
UDWord	3-phase : apparent power	
Word	3-phase : power factor	1/100
Word	3-phase : sector of power factor (cap or ind)	1 : ind 2 : cap
Word	Frequency	Hz/10
UDWord	Phase 1 : active power	
UDWord	Phase 2 : active power	
UDWord	Phase 3 : active power	
UDWord	Phase 1 : reactive power	
UDWord	Phase 2 : reactive power	
UDWord	Phase 3 : reactive power	
Word	Phase 1 : power factor	1/100
Word	Phase 2 : power factor	1/100
Word	Phase 3 : power factor	1/100
Word	Phase 1 : power factor sector	1 : ind
Word		2 : cap
Word	Phase 2 : power factor sector	1 : ind
Word		2 : cap
Word	Phase 3 : power factor sector	1 : ind
Word		2 : cap
Word	Output relay status	

Revisione A

M. D'Onofrio

A. Rigamonti

M. D'Onofrio

Compilato

Controllato

Approvato

NEMO 96 EA ModBus
Type 2

Type	Description	Unit
UDWord	Phase 1 : current	mA
UDWord	Phase 2 : current	mA
UDWord	Phase 3 : current	mA
UDWord	Neutral current	mA
UDWord	Chained voltage : L1-L2	mV
UDWord	Chained voltage : L2-L3	mV
UDWord	Chained voltage : L3-L1	mV
UDWord	3-phase : active power	
UDWord	3-phase : reactive power	
UDWord	3-phase : apparent power	
Word	3-phase : power factor	1/100
Word	3-phase : sector of power factor (cap or ind)	1 : ind 2 : cap
Word	Frequency	Hz/10
Word	Output relay status	

Type 3

Type.	Description	Unit
UDWord	Phase 1 : phase voltage	mV
UDWord	Phase 2 : phase voltage	mV
UDWord	Phase 3 : phase voltage	mV
UDWord	Phase 1 : current	mA
UDWord	Phase 2 : current	mA
UDWord	Phase 3 : current	mA
UDWord	Neutral current	mA
UDWord	3-phase : active power	
UDWord	3-phase : reactive power	
UDWord	3-phase : apparent power	
WORD	3-phase : power factor	1/100
WORD	3-phase : sector of power factor (cap or ind)	1 : ind 2 : cap
WORD	Frequency	Hz/10
WORD	Output relay status	

Revisione A

M. D'Onofrio

A. Rigamonti

M. D'Onofrio

Compilato

Controllato

Approvato

14.1. Real time data Type 4: bit mapped variable reading

For Data Type 0, 1, 2, 3 there is a fixed format; Data Type 4 has a variable format for data. This means that in the case of Data Type 4 user can choose which variable to save. To select the right measurements, there is a bit map that can be read or written.

Address : 0x3700
Format : b34 ... b0

The variable is 10 BYTES long but only the LSByte 4..0 are used at the moment. If a 1 is written in the proper position, the correspondent variable is stored.

b34 relay status
b33 THD I3
b32 THD I2

b31 THD I1
b30 THD V3
b29 THD V2
b28 THD V1
b27 PF3 sect
b26 PF2 sect
b25 PF1 sect
b24 PF3

b23 PF2
b22 PF1
b21 Q3
b20 Q2
b19 Q1
b18 P3
b17 P2
b16 P1

b15 Freq
b14 Pf sect
b13 PF
b12 S
b11 Q
b10 P
b9 V31
b8 V23

b7 V12
b6 In
b5 I3
b4 I2
b3 I1
b2 V3
b1 V2
b0 V1

Revisione A	M. D'Onofrio	A. Rigamonti	M. D'Onofrio
	Compilato	Controllato	Approvato

	COMMUNICATION PROTOCOL	PR 150	Rev. A
		31/01/2018	Pag 33
Multifunction		Firmware ≥ 1.101	
NEMO 96 EA ModBus			

For example :

Answer DEV 03 37 00 00 05 CRC_HCRC_L
 Response DEV 03 0A 00 00 00 00 00 00 87 65 43 21 CRC_LCRC_H

00000000 00000000 00000000 00000000 00000000 00000000 10000111 01100101 01000011 00100001
b34 b0

Any record is composed as in the following :

- b31 THD I1
- b26 PF2 sect
- b25 PF1 sect
- b24 PF3

- b22 PF1
- b21 Q3
- b18 P3
- b16 P1

- b14 Pf sect
- b9 V31
- b8 V23

- b5 I3
- b0 V1

14.2. Real time data Type 4 : bit mapped variable writing

To write the bit mapped variable, the following procedure is mandatory :

Write 0x5AA5 to 0x2700 to unlock the procedure
 Write at 0x3700 the data

Command1 DEV 10 27 00 00 01 02 5A A5 CRC_HCRC_L
 Answer DEV 10 27 00 00 01 16 CRC_HCRC_L

Command2 DEV 10 37 00 00 05 0A 00 [51] 00 [52] 00 [53] 00 [54] 00 [05] CRC_HCRC_L
(A) (B) (C) (D) (E)

WARNING : NO ANSWER because NEMO96 EA reset itself.

(A)	00000000	01010001		b7	b6	b5	b4	b3	b2	b1	b0
(B)	00000000	01010010		b15	b14	b13	b12	b11	b10	b9	b8
(C)	00000000	01010011		b23	b22	b21	b20	b19	b18	b17	b16
(D)	00000000	01010100		b31	b30	b29	b28	b27	b26	b25	b24
(E)	00000000	00000101		b34	b33	b32					

Revisione A	M. D'Onofrio	A. Rigamonti	M. D'Onofrio
	Compilato	Controllato	Approvato

	COMMUNICATION PROTOCOL	PR 150	Rev. A
		31/01/2018	Pag 34
Multifunction		Firmware ≥ 1.101	
NEMO 96 EA ModBus			

14.3. Real time Type 4 data reading

As an example of data reading, in this case we have :

Set as starting date 01/01/01 and as time 00:00:00

```
Command    DEV 10 5A 00 00 06 0C 00 01 00 01 00 01 00 00 00 00 00 00 00 00 CRCL CRCH
Answer     DEV 10 5A 00 00 06 CRCL CRCH
```

Read data records :

```
Command    DEV 03 50 10 00 00 00 CRCL CRCH
Answer
```

```
[DEV] [03] [d0]
[13] [12] [11] [16] [59] [12]   13/12/11   16:59:12
```

```
(BLOCK A)
[00] [02] [c3] [6c]   V1
[00] [00] [04] [c9]   I2
[00] [00] [04] [19]   In
[00] [05] [4e] [34]   V31
[00] [01] [22] [ea]   S
[00] [01]             Sect PF
[00] [00] [26] [d3]   P1
[00] [00] [59] [a7]   P2
[00] [00] [20] [f6]   Q2
[00] [5d]             PF1
[00] [01]             Sect PF2
[00] [00]             V1 THD
[00] [00]             V3 THD
[00] [02]             I2 THD
[00] [00]             Relay Status
```

```
[13] [12] [11] [16] [59] [14]   13/12/11   16:59:14
```

(AS BLOCK A)

```
[13] [12] [11] [16] [59] [16]   13/12/11   16:59:16
```

(AS BLOCK A)

CRC_H CRC_L

Revisione A	M. D'Onofrio	A. Rigamonti	M. D'Onofrio
	Compilato	Controllato	Approvato

	COMMUNICATION PROTOCOL	PR 150	Rev. A
		31/01/2018	Pag 35
Multifunction		Firmware ≥ 1.101	
NEMO 96 EA ModBus			

15. Power quality reading

Set as starting date 01/01/01 and as time 00:00:00

Command DEV 10 54 F0 00 06 0C 00 01 00 01 00 01 00 00 00 00 00 00 00 CRC_H CRC_L
 Answer DEV 10 54 F0 00 06 CRC_H CRC_L

Dips/Swells/Interruptions/RVCs events;

The answer for a request at the address listed in the table will be

- Error data with incorrect data (code 0x83) if no data has been saved in the device
- An answer with variable length (depending on the data saved). The events will be listed by the last one happened to the older one. When a new events is saved the older one will be lost. For each events you can find.
 - Time stamp (BCD) that is the date when the event was happened
 - i.e. 0x07 0x09 0x16 0x23 0x12 0x44 means September 7th 2016 11.12.44 p.m.
 - The duration in msec of the event
 - The residual voltage for each phase (mV)
 - Dip: minimum voltage for each phase
 - Interruption: minimum voltage for each phase
 - Swell: maximum voltage for each phase
 - RVC: deviation of each phase from the steady state

Tx DEV 03 18 06 00 02 CRC_H CRC_L => Dips requests

Rx

DEV 03 8C

07 09 17 05 54 43 00 14 00 02 E3 88 00 03 73 66 00 02 CA 7E (*)

30 07 17 20 24 35 00 3C 00 03 38 EC 00 02 97 FC 00 03 27 F8

09 07 17 10 24 15 00 28 00 02 94 6E 00 03 54 26 00 03 3F 68

09 07 17 10 22 03 00 28 00 02 93 E2 00 03 52 FA 00 03 3B 58

28 06 17 16 46 36 00 14 00 02 D3 48 00 02 C7 E0 00 03 6C 54

02 01 16 11 19 31 00 21 00 02 C8 6C 00 02 BB 24 00 03 7D 52

01 01 16 00 00 07 00 14 00 02 79 16 00 03 68 12 00 03 75 D2

CRC_H CRC_L

Tx DEV 03 18 08 00 02 CRC_H CRC_L

=> Swell

Rx DEV 83 02 CRC_H CRC_L

=> No data available

Tx DEV 03 18 07 00 02 CRC_H CRC_L

=> Interruptions

Rx DEV 83 02 CRC_H CRC_L

=> No data available

Tx DEV 03 18 09 00 02 CRC_H CRC_L

=> RVC's request

Rx

DEV 03 F0

24 09 17 09 23 24 00 F0 00 00 2D 28 00 00 37 D2 00 00 2C F6

21 08 17 12 35 52 01 18 00 00 6C 16 00 00 22 4C 00 00 71 3E

10 08 17 23 38 10 01 04 00 00 34 26 00 00 33 86 00 00 32 B4

08 08 17 20 08 23 00 E6 00 00 1C 7A 00 00 1B 1C 00 00 37 A0

07 08 17 07 19 47 01 0E 00 00 1D 10 00 00 9D 12 00 00 9C 9A

06 08 17 14 16 39 00 F0 00 00 0F FA 00 00 47 18 00 00 3B 1A

06 08 17 11 00 19 00 FA 00 00 33 40 00 00 22 9C 00 00 29 54

04 08 17 10 28 09 00 E6 00 00 1F 90 00 00 36 2E 00 00 12 F2

03 08 17 19 11 55 00 F0 00 00 24 36 00 00 36 CE 00 00 22 88

24 07 17 02 48 09 00 F0 00 00 43 12 00 00 3E 3A 00 00 23 B4

21 07 17 21 48 39 01 2C 00 00 21 84 00 00 2E 68 00 00 70 9E

19 07 17 17 41 09 01 18 00 00 30 FC 00 00 2F A8 00 00 30 52

CRC_H CRC_L

Revisione A	M. D'Onofrio	A. Rigamonti	M. D'Onofrio
	Compilato	Controllato	Approvato

	COMMUNICATION PROTOCOL	PR 150	Rev. A
		31/01/2018	Pag 36
Multifunction		Firmware ≥ 1.101	
NEMO 96 EA ModBus			

(*) meaning

07 09 17 05 54 43 00 14 00 02 E3 88 00 03 73 66 00 02 CA 7E

07 09 17 05 54 43 Time stamp September 9th 2017 5h54m14s a.m. 0014 Duration 20msec

00 02 E3 88 00 03 73 66 00 02 CA 7E residual voltages V1=189.32V, V2=226.15V, V3=182.91V

For all answer regarding data saved, the answer could exceed the maximum number of byte of an modbus answer, this means that could be there saved more datas. It is possible to have the next one with a new request **DEV 03 18 09 00 02 CRC_H CRC_L** (i.e. RVC's request) and the device will give the next. It's not necessary to re-send a new date because the device keeps memory of the last data sent.

Revisione A	M. D'Onofrio	A. Rigamonti	M. D'Onofrio
	Compilato	Controllato	Approvato